



Best tools for your Golden time

# Automatic Wire Stripper

## IWS-6 RANGE: 0.3 ~ 3.0mm



**GOLDSTAR**  
Korea Technology  
Type: IWS-6  
Wire: 0.3 - 3 mm



DESIGN & QUALIFIED IN KOREA



## PRODUCT DETAILS

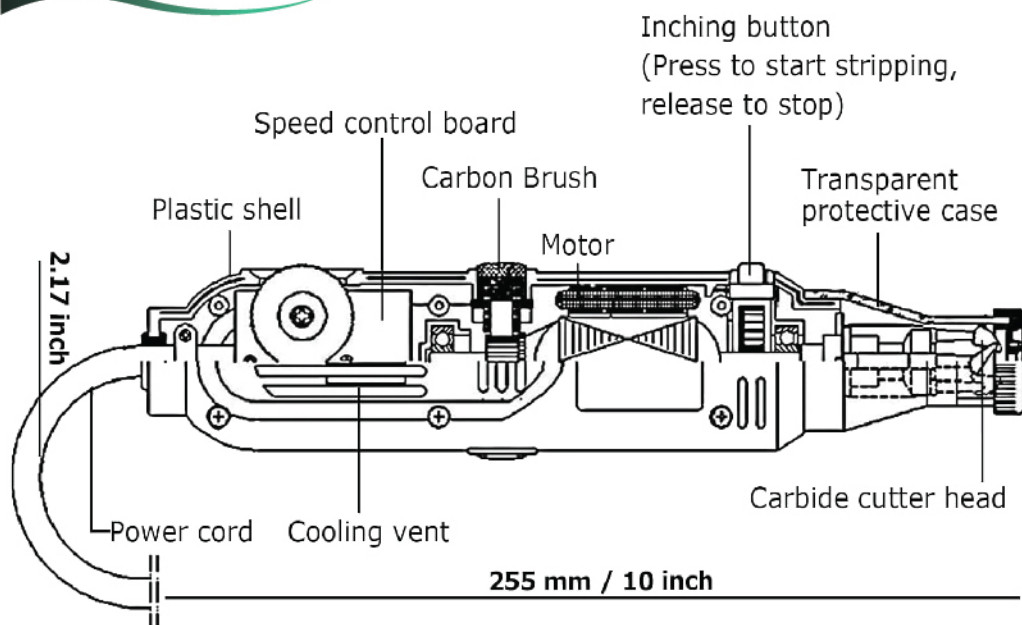

<b>MODEL</b>	IWS-6	<b>RANGE</b>	0.3 ~ 3.0 mm
<b>SPEED</b>	1200r / min	<b>WEIGHT</b>	0.75 kg / 1.65 lbs
<b>VOLTAGE</b>	220V 50HZ	<b>POWER</b>	75W
<b>LENGTH</b>	2 ~ 50mm	<b>SIZE</b>	255 * 55mm * 55mm

## APPLICABLE WIRE DIAMETER

Easily strip paint from enameled wire in just two seconds

Applicable enameled wire diameter range  
0.3~3.0mm / 0.0118"-0.1181"



## SIX-SPEED STEPLESS SPEED REGULATION

Gear 1 is the slowest, gear 6 is the fastest. If you need to scrape thin enameled wires, please adjust to "Slow" speed; if you need to scrape thick enameled wires, please adjust to "Fast" speed.



## PRODUCT DETAILS

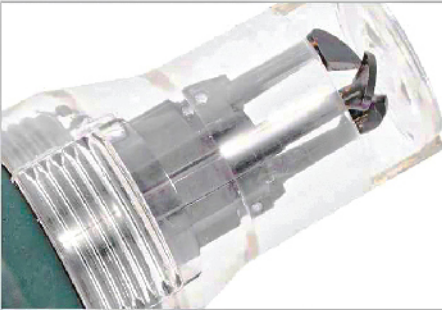

### **TRANSPARENT PP MATERIAL**

Transparent and clear, easy to operate. High-quality material, hard and not easy to crack to prevent dust from flying.

### **WEAR-RESISTANT AND DURABLE**

The three-jaw cutter head is made of tungsten steel welded to the handle, which is suitable for different enameled wire diameters.



### **6-SPEED STEPLESS SPEED REGULATION**

It is suitable for various wire diameters in the range of 0.3~3.0mm, and can be adjusted according to your own habits. The stripping speed is more flexible.



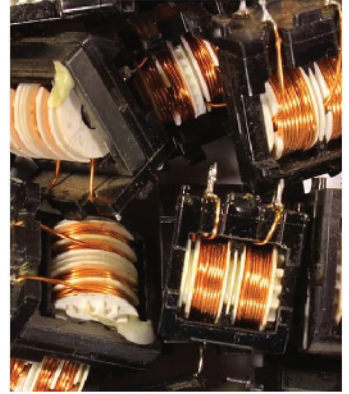

## SCOPE OF APPLICATION

It is a paint scraping tool for coil manufacturing and maintenance industries such as motors, electrical appliances, meters, transformers, electronics, household appliances and power tools.

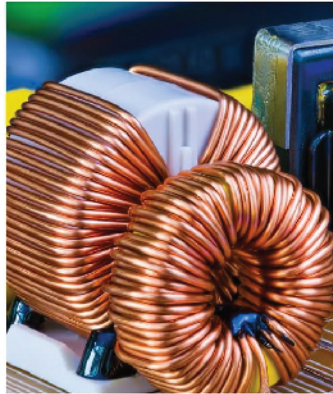
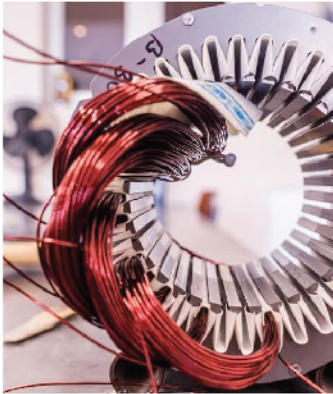

## PRODUCT ADVANTAGES

### Electric Magnet Wire Stripping Machine

Traditional paint scraping method:  
slow work and poor effect



#### SANDPAPER

High working intensity  
Poor workpiece quality



#### GRINDING WHEEL

High power consumption  
Poor workpiece quality



#### SCRAPE WITH A KNIFE

Time consuming and laborious  
Failed to scrape paint completely



- ✓ High paint stripping efficiency
- ✓ Strip the paint clean
- ✓ Good workpiece quality

# HOW TO USE THIS MAGNET WIRE STRIPPING MACHINE?



1. Put the straightened enameled wire into the center of the cutter head.

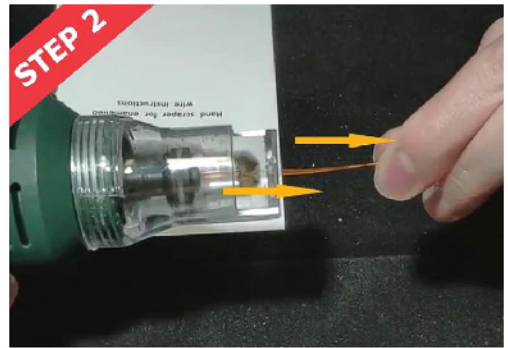

2. Move the enameled wire in the opposite direction of the shaft.



3. Release the power button switch to stop working.

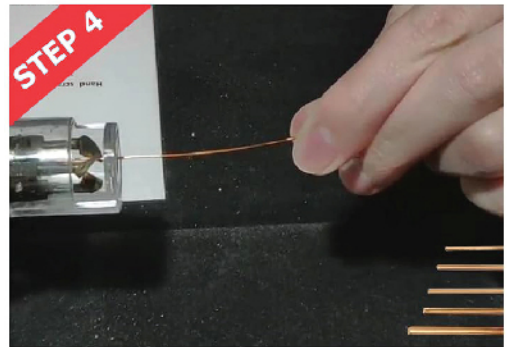

4. Replace other enameled wires and repeat the above steps.



*Goldstar's Korean automatic wire stripping machine model IWS-6 is used for polished copper wires with shiny coating, wires with fiber coating (glass coating) and wires with PVC insulation.*

Your distributor Goldstar / Your agent