

# SKN 141F



**Stud Diode**

## Fast Recovery Rectifier Diode

**SKN 141F**

**SKR 141F**

### Features

- Small recovered charge
- Soft recovery
- Hermetic metal case with glass insulator
- Threaded stud M12
- SKN: anode to stud;  
SKR: cathode to stud

### Typical Applications\*

- Inverse diode for GTO and asymmetric thyristor
- Inverters and choppers
- A.C. motor control
- Uninterruptible power supplies (UPS)

$V_{RSM}$ V	$V_{RRM}$ V	$I_{FRMS} = 260$ A (maximum value for continuous operation) $I_{FAV} = 140$ A (sin. 180; 1000 Hz; $T_c = 100$ °C)	
1200	1200	SKN 141F12	SKR 141F12
1400	1400	SKN 141F14	SKR 141F14
1500	1500	SKN 141F15	SKR 141F15
1700	1700	SKN 141F17	SKR 141F17

Symbol	Conditions	Values	Units
$I_{FAV}$	sin. 180; $T_c = 85$ (100) °C	168 (140)	A
$I_{FAV}$	K1,1F; $T_a = 35$ °C; sin. 180; 1000 Hz	114	A
$I_{FSM}$	$T_{vj} = 25$ °C; 10 ms	2500	A
	$T_{vj} = 150$ °C; 10 ms	2100	A
$i^2t$	$T_{vj} = 25$ °C; 8,3 ... 10 ms	31000	A <sup>2</sup> s
	$T_{vj} = 150$ °C; 8,3 ... 10 ms	22000	A <sup>2</sup> s
$V_F$	$T_{vj} = 25$ °C; $I_F = 300$ A	max. 1,8	V
$V_{(TO)}$	$T_{vj} = 150$ °C	max. 1,1	V
$r_T$	$T_{vj} = 150$ °C	max. 2	mΩ
$I_{RD}$	$T_{vj} = 25$ °C; $V_{RD} = V_{RRM}$	max. 1	mA
$I_{RD}$	$T_{vj} = 150$ °C; $V_{RD} = V_{RRM}$	max. 100	mA
$Q_{rr}$	$T_{vj} = 150$ °C, $I_F = 100$ A,	90	μC
$I_{RM}$	$-di/dt = 100$ A/μs, $V_R = 400$ V	90	A
$t_{rr}$		2000	ns
$E_{rr}$		-	mJ
$R_{th(j-c)}$		0,2	K/W
$R_{th(c-s)}$		0,08	K/W
$T_{vj}$		- 40 ... + 150	°C
$T_{stg}$		- 55 ... + 150	°C
$V_{isol}$		-	V~
$M_s$	to heatsink	10	Nm
$a$		5 * 9,81	m/s <sup>2</sup>
$m$	approx.	75	g
Case		E 31	

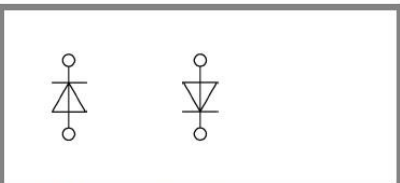

**SKN**

**SKR**

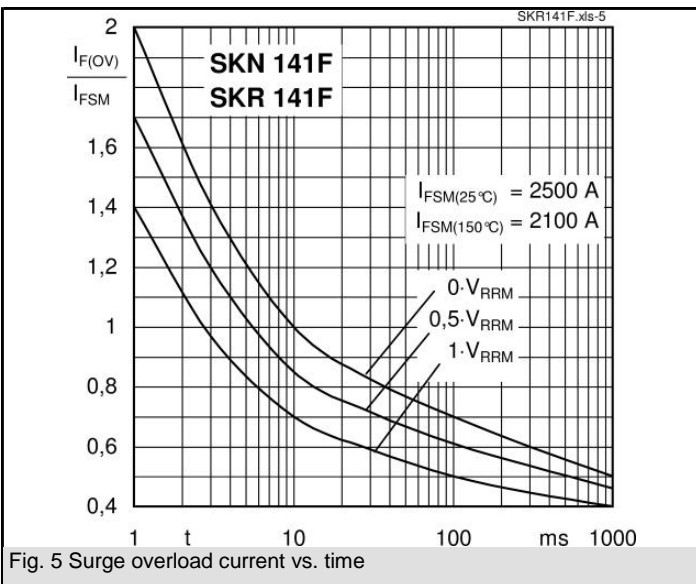
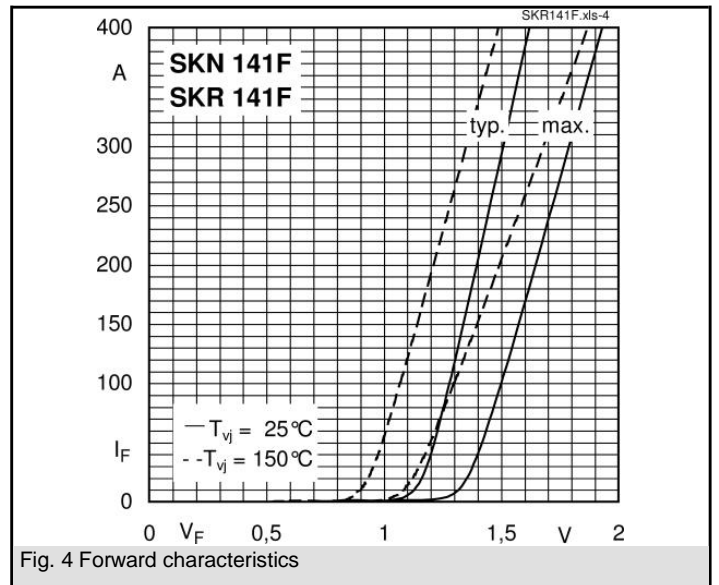
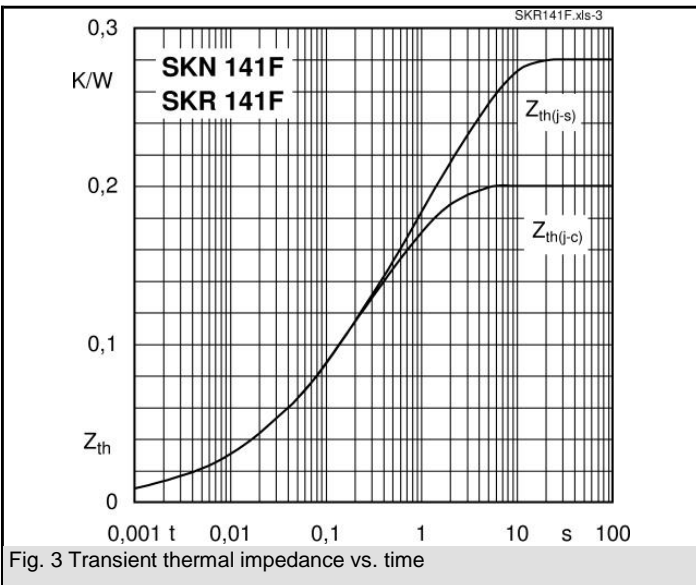
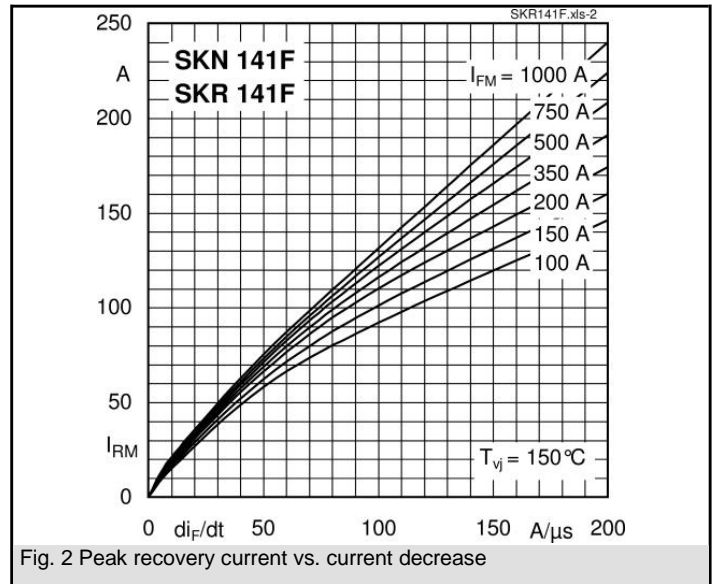
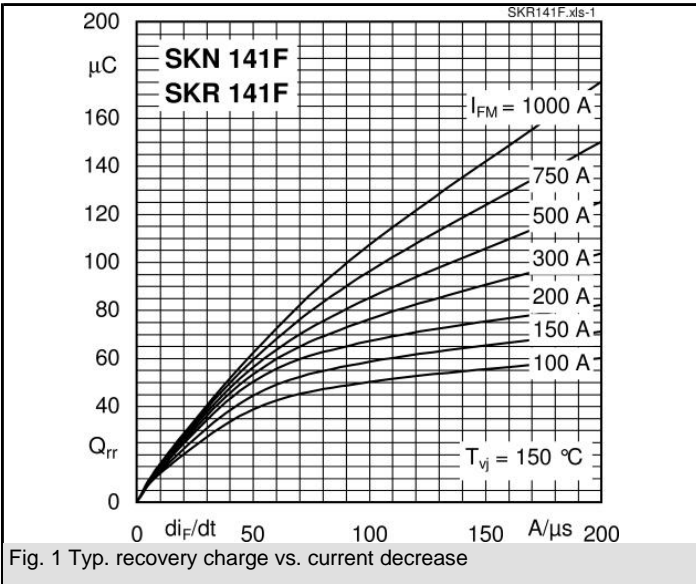

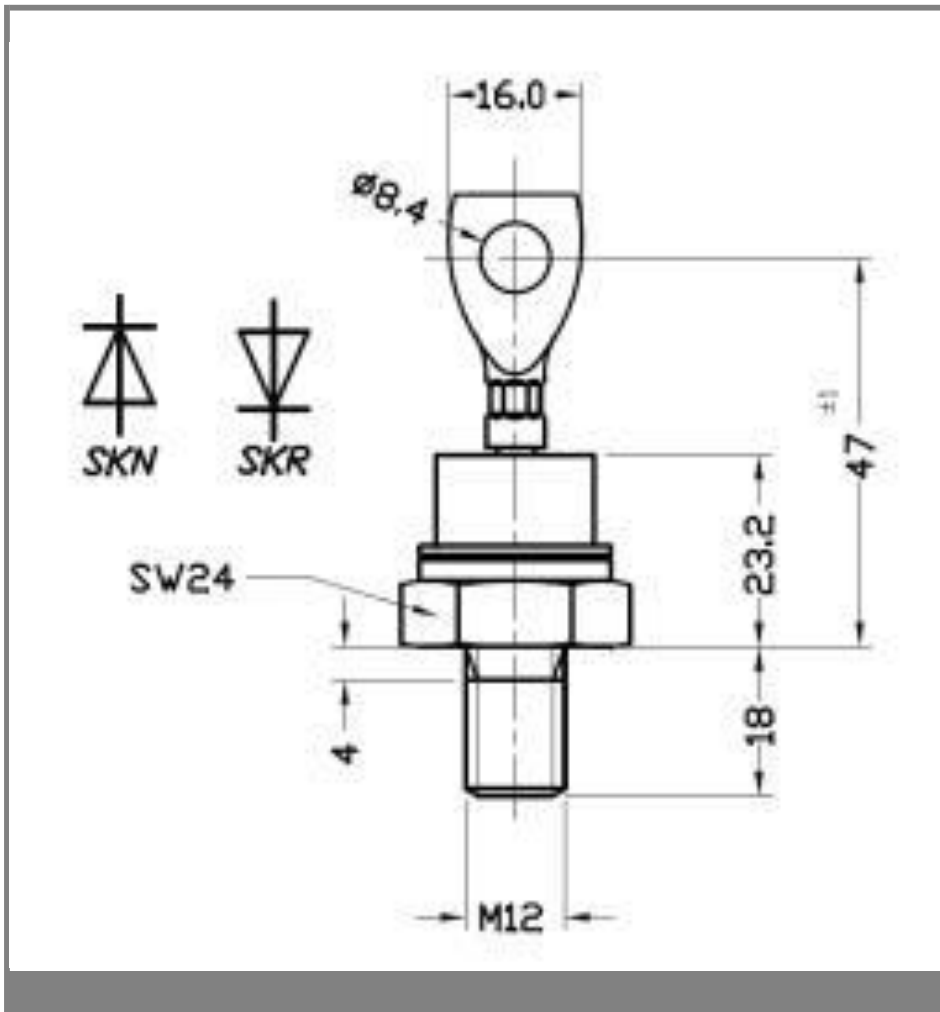

\* The specifications of our components may not be considered as an assurance of component characteristics. Components have to be tested for the respective application. Adjustments may be necessary. The use of SEMIKRON products in life support appliances and systems is subject to prior specification and written approval by SEMIKRON. We therefore strongly recommend prior consultation of our personal.